

Up to 4Gbps
1.27 mm
Dual Rows



HIGH-SPEED CONNECTORS

Board-to-Board
IDC Socket
Cable Assembly

5G Networks, LTE / Network Switches and Wireless Routers /
Radars and Gateways / Power Supplies / Remote Radio Units

CONTENT

	CONCEPT	1
	CHARACTERISTICS	2
	ADVANTAGES	3
	HIGH FREQUENCY CHARACTERISTICS	4 - 5
<hr/>		
Board-to-Board	GBEC207 SERIES	7
	GBEC208 SERIES	8
	GBEC209 SERIES	9
	GBED204 SERIES	10
	CBEC223 SERIES	11
	CBEC224 SERIES	12
	CBEC225 SERIES	13
	CBEC227 SERIES	14
	CBED202 SERIES	15
<hr/>		
IDC Socket	GQEC201 SERIES	17
<hr/>		
Cable Assemblies	CQEA217 SERIES	19
	LQQE2XX SERIES	20
<hr/>		
	MATING	21
	PACKAGING	22 - 23

CONCEPT

■ GENERAL

The system series is designed specifically with robust terminals and high-temperature plastic for high-speed industrial applications. The unique contact structure allows it to maintain a steady impedance profile, which ultimately minimizes both the noise and signal loss over the connectivity, with a potential secure data transmission up to 8Gbps. (4Gbps differential signaling, two pairs are driven.)

■ SPECIFICATION

Electrical	Description	Standard
Current Rating	1.7A/Pin(PCB); 0.8A/Pin(Cable)	
Withstand Voltage	AC 500V	EIA-364-20
Contact Resistance	25 mΩ or lower	EIA-364-23
Insulation Resistance	10000 MΩ or higher	EIA-364-21
Temperature Rise	ΔT30° C Maximum	EIA-364-70

Mechanical	Description	Standard
Mechanical Shock	Instant rupture ≤ 1 μs Max.	
Durability	500 cycles	EIA-364-09
Contact Retention Force	≥ 0.1N / Pin	EIA-364-37
Mating / Unmating Force	≤ 0.5N / Pin	EIA-364-13
Vibration, Sine	Instant rupture ≤ 1 μs Max.	EIA-364-28
Shock, Half Sine	Instant rupture ≤ 1 μs Max.	EIA-364-27

Environment	Description	Standard
Operating Temperature / Humidity	-55°C to 125°C / 85% or lower	
Salt Spray	Test Condition: Atmosphere: 5% salt-solution	EIA-364-26
Thermal Shock	No puncture, contact resistance <35mΩ	EIA-364-32
Temperature Life	Test Condition: 105°C, 96 hrs.	EIA-364-17
Humidity Test	Test Condition: 40±2°C, 90-95% RH, 96 hrs.	EIA-364-31
Resistance to Soldering Heat	Peak Temp.: 260°C/10s Maximum	EIA-364-56

CHARACTERISTICS

■ ALLOWED DEGREE OF ANGULAR MISALIGNMENT THAT ENSURES A SECURE MATING PROCESS

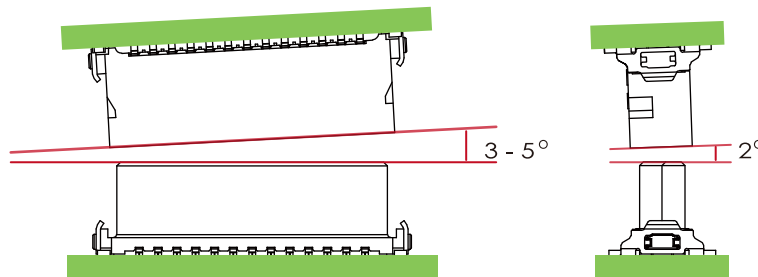

The allowable horizontal angular misalignment is 3 to 5° (dependent on the number of pins); and, the allowable vertical angular misalignment is 2° Max.

■ ALLOWED LINEAR MISALIGNMENT THAT ENSURES A SECURE MATING PROCESS

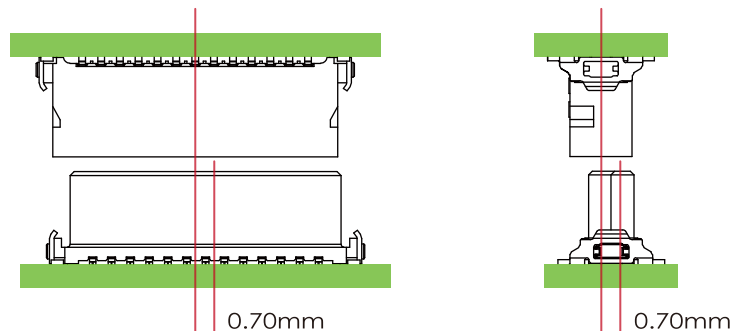

The allowable horizontal and vertical linear misalignment is: $\pm 0.70\text{mm}$ Max.

■ CAPABILITIES

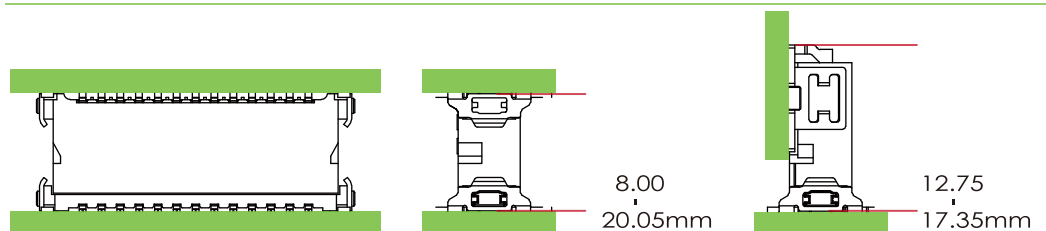

The effective mating distances between PCBs using these board-to-board connectors are shown in the figures above.

■ APPLICATIONS

- | | |
|--------------------|---|
| Automotive: | charging systems, battery management systems, motor controllers |
| Industrial: | factory equipment, production line controls, large drives |
| Telecommunication: | portable monitoring equipment, data collectors, mobile maintenance and display control systems, trackside and roadside monitors |

ADVANTAGES

■ POSITIONING POSTS



■ ROBUST SOLDER CLIPS



■ CHAMFER

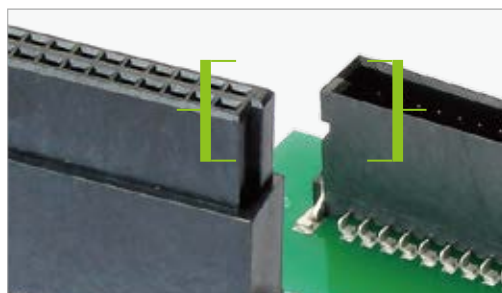

HIGH FREQUENCY CHARACTERISTICS

■ HIGH SPEED DATA TRANSMISSION

These series of connectors are designed specifically for secure data transmission, with a potential transmission rate of up to 8Gbps. Aside from their reliable high-speed performance, they are also robust making them ideal for any kind of high-speed application.

■ INSERTION LOSS

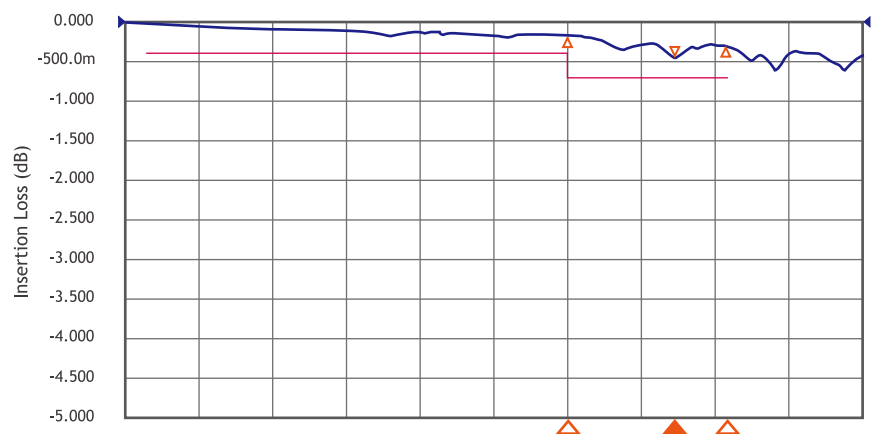

■ NEAR END CROSSTALK

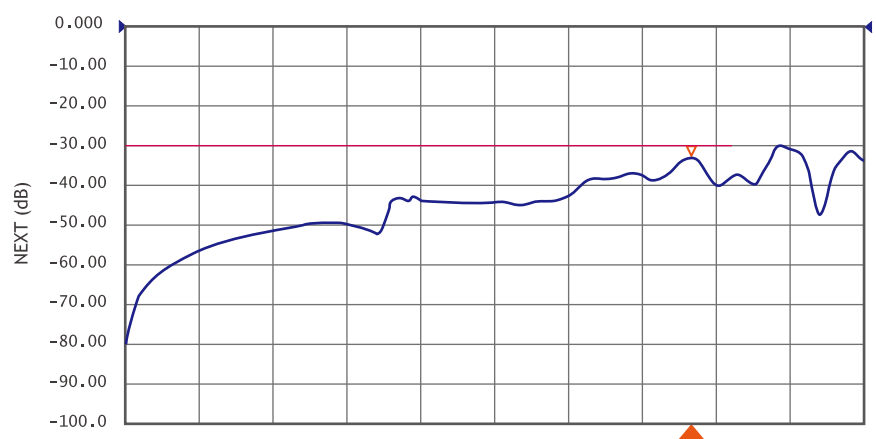

■ RETURN LOSS

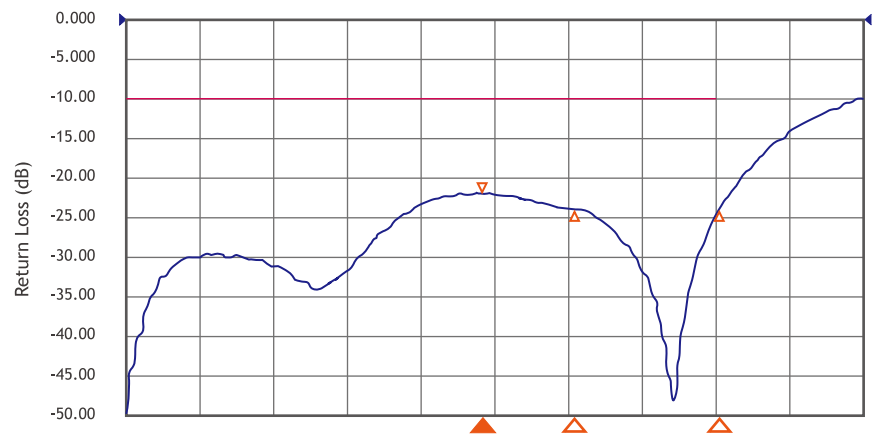

■ IMPEDANCE

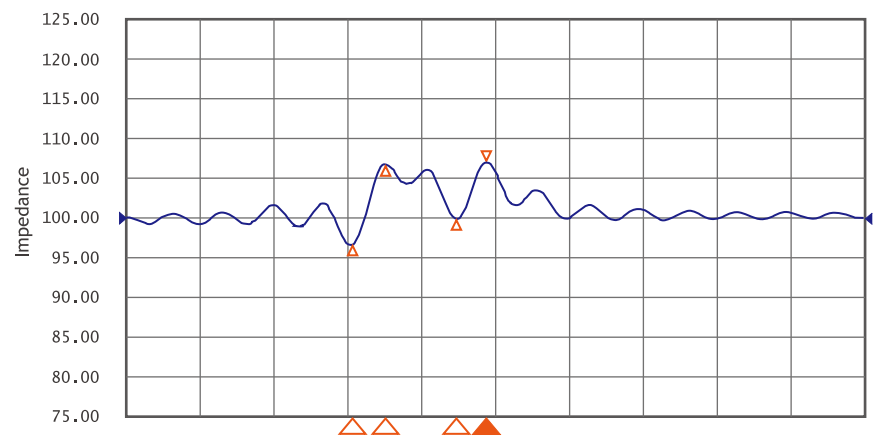

Board-to-Board

male

07

GBEC207



08

GBEC208



09

GBEC209



10

GBED204



11

CBEC223



12

CBEC224



13

CBEC225



14

CBEC227



15

CBED202



female

GBEC207

SERIES

Male

S.M.T.



PRODUCT SPECIFICATIONS

Current Rating : 1.7 Amp / PIN

Contact Resistance : 25 mΩ Max.

Dielectric Withstanding Voltage : 500 VAC

Insulation Resistance : 10000 MΩ Min.

Operating Temperature : -55 °C to +125 °C

All materials must meet GREENCONN hazardous substances control standards.



DIMENSIONAL DRAWINGS

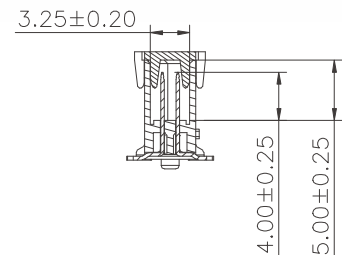
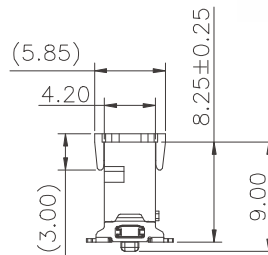
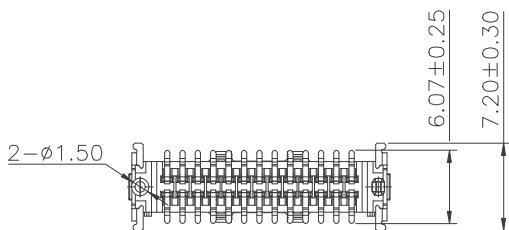
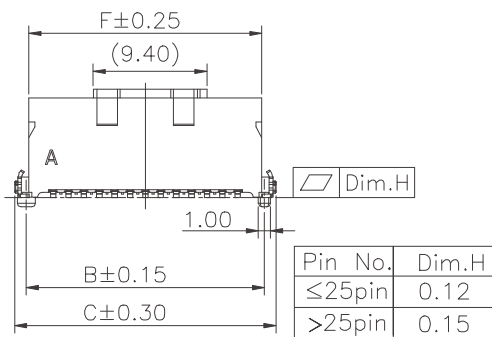
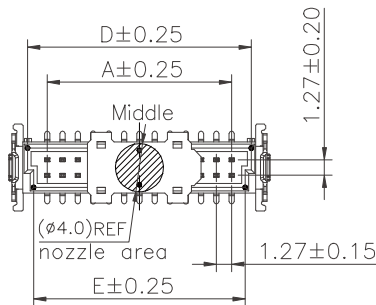

Recommended P.C.Board
Layout
(Tolerance:±0.05)

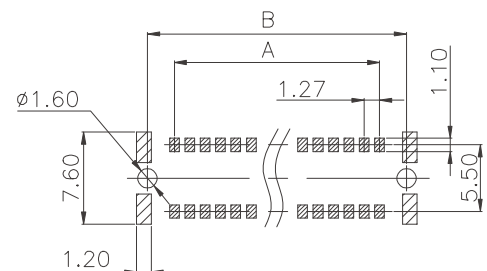

No. of PIN/ROW	Dimension Information					
	A	B	C	D	E	F
2x05	5.08	9.50	11.43	8.30	7.30	9.08
2x06	6.35	10.77	12.70	9.57	8.57	10.35
2x08	8.89	13.31	15.24	12.11	11.11	12.89
2x10	11.43	15.85	17.78	14.65	13.65	15.43
2x13	15.24	19.66	21.59	18.46	17.46	19.24
2x16	19.05	23.47	25.40	22.27	21.27	23.05
2x20	24.13	28.55	30.48	27.35	26.35	28.13
2x25	30.48	34.90	36.83	33.70	32.70	34.48
2x34	41.91	46.33	48.26	45.13	44.13	45.91
2x40	49.53	53.95	55.88	52.75	51.75	53.53

Ordering Information

GBEC207 -

No. of Pins per Row

05 10 20 34 40

06 13 25

08 16

Standard Plating

05 : 1u" Au / 80~160u" Tin

Selective Plating

79 : 5u" Au / 80~160u" Matte Tin

B001C

Color

1 : Black

A

Standard Packing

F : Cap + Tape&Reel

Selective Packing

C : Tube

E : Cap + Tube

GBEC208

SERIES

Male

S.M.T.

Pitch 1.27 mm

HIGH-SPEED

PRODUCT SPECIFICATIONS

Current Rating : 1.7 Amp / PIN

Contact Resistance : 25 mΩ Max.

Dielectric Withstanding Voltage : 500 VAC

Insulation Resistance : 10000 MΩ Min.

Operating Temperature : -55 °C to +125 °C

All materials must meet GREENCONN hazardous substances control standards.



DIMENSIONAL DRAWINGS

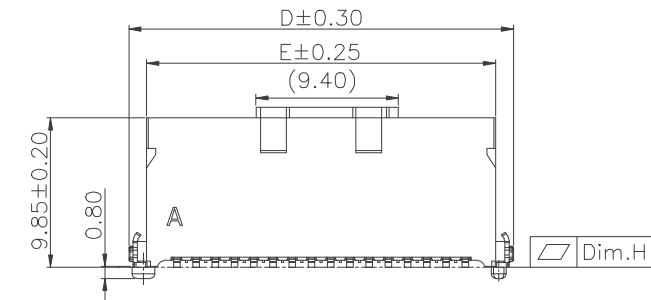
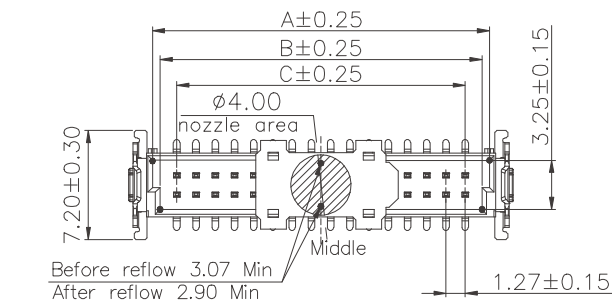

Pin No.	Dim.H
≤ 25pin	0.12
> 25pin	0.15

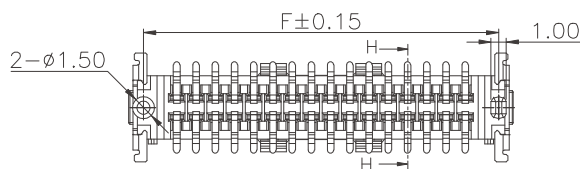

No. of PIN/ROW	Dimension Information					
	A	B	C	D	E	F
2x5	8.30	7.30	5.08	11.43	9.08	9.50
2x6	9.57	8.57	6.35	12.70	10.35	10.77
2x8	12.11	11.11	8.89	15.24	12.89	13.31
2x10	14.65	13.65	11.43	17.78	15.43	15.85
2x13	18.46	17.46	15.24	21.59	19.24	19.66
2x16	22.27	21.27	19.05	25.40	23.05	23.47
2x20	27.35	26.35	24.13	30.48	28.13	28.55
2x25	33.70	32.70	30.48	36.83	34.48	34.90
2x34	45.13	44.13	41.91	48.26	45.91	46.33
2x40	52.75	51.75	49.53	55.88	53.53	53.95

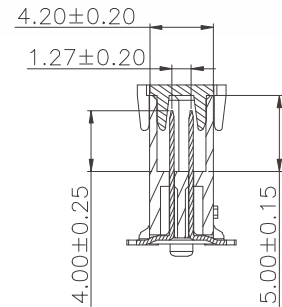

Recommended P.C.Board Layout
(Tolerance:±0.05)

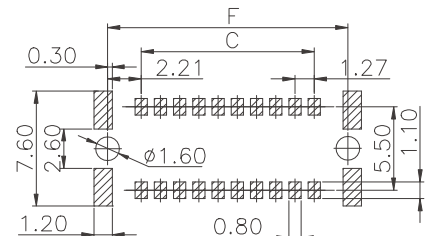

Ordering Information

GBEC208 -

No. of Pins per Row

Standard Plating

: 1u" Au / 80~160u" Tin

Selective Plating

: Gold Flash

: 5u" Au / 80~160u" Matte Tin

B001C

Color

: Black

A

Standard Packing

: Cap + Tape&Reel

Selective Packing

: Tube

: Cap + Tube

GBEC209

SERIES

Male

S.M.T.



PRODUCT SPECIFICATIONS

- Current Rating : 1.7 Amp / PIN
- Contact Resistance : 25 mΩ Max.
- Dielectric Withstanding Voltage : 500 VAC
- Insulation Resistance : 10000 MΩ Min.
- Operating Temperature : -55 °C to +125 °C

All materials must meet GREENCONN hazardous substances control standards.



DIMENSIONAL DRAWINGS

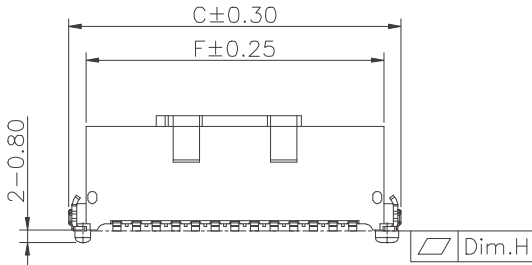
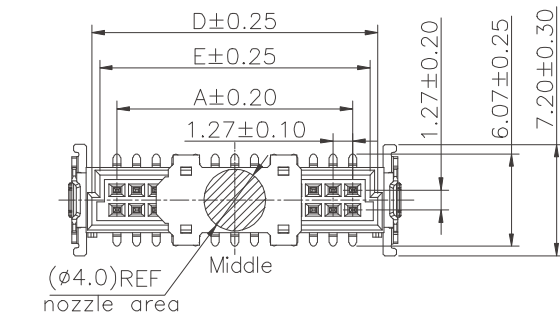

Pin No.	Dim.H
≤ 25 Pin	0.12
> 25 Pin	0.15

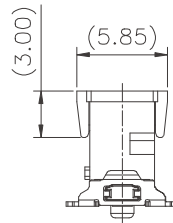
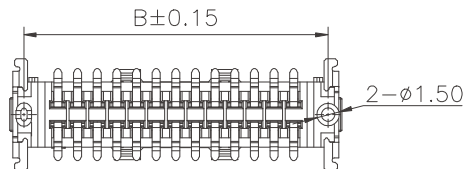

No. of PIN/ROW	Dimension Information					
	A	B	C	D	E	F
2x05	5.08	9.50	11.30	8.30	7.30	9.08
2x06	6.35	10.77	12.57	9.57	8.57	10.35
2x08	8.89	13.31	15.11	12.11	11.11	12.89
2x10	11.43	15.85	17.65	14.65	13.65	15.43
2x13	15.24	19.66	21.46	18.46	17.46	19.24
2x16	19.05	23.47	25.27	22.27	21.27	23.05
2x20	24.13	28.55	30.35	27.35	26.35	28.13
2x25	30.48	34.90	36.70	33.70	32.70	34.48
2x34	41.91	46.33	48.13	45.13	44.13	45.91
2x40	49.53	53.95	55.75	52.75	51.75	53.53

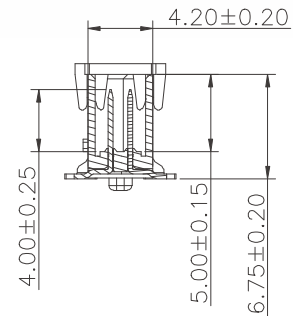

Recommended P.C.Board Layout
(Tolerance: ± 0.05)

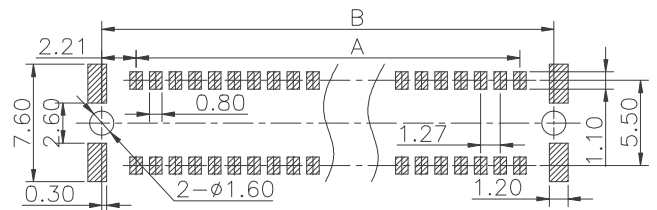

Ordering Information

GBEC209 -

No. of Pins per Row

-
-
-

Standard Plating

: 1u" Au / 80~160u" Tin

Selective Plating

- : Gold Flash
- : 5u" Au / 80~160u" Matte Tin

B001C

Color

: Black

A

Standard Packing

: Cap + Tape&Reel

Selective Packing

: Tube

: Cap + Tube

GBED204

SERIES

Male

S.M.T. R/A

Pitch 1.27 mm

HIGH-SPEED

PRODUCT SPECIFICATIONS

- Current Rating : 1.7 Amp / PIN
- Contact Resistance : 25 mΩ Max.
- Dielectric Withstanding Voltage : 500 VAC
- Insulation Resistance : 10000 MΩ Min.
- Operating Temperature : -55 °C to +125 °C



All materials must meet GREENCONN hazardous substances control standards.

DIMENSIONAL DRAWINGS

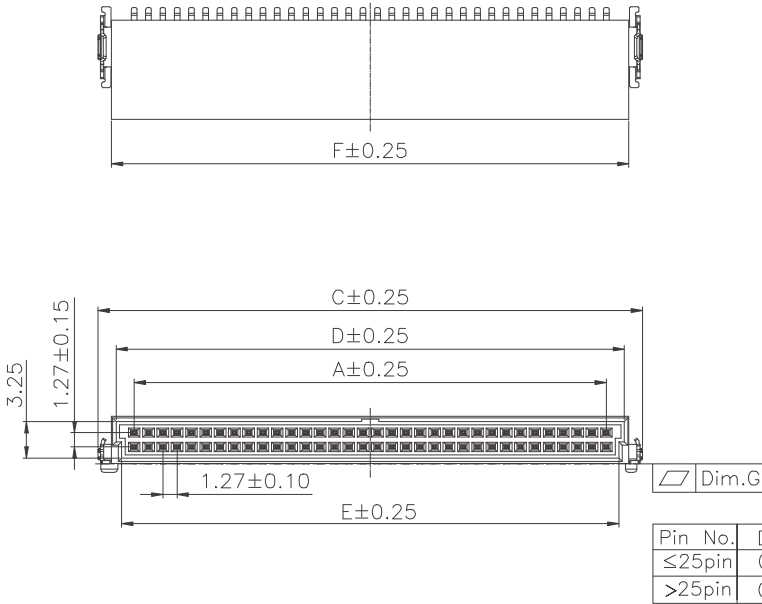

No. of PIN/ROW	Dimension Information					
	A	B	C	D	E	F
2X05	5.08	9.50	11.50	8.30	7.30	9.10
2X06	6.35	10.77	12.77	9.57	8.57	10.37
2X08	8.89	13.31	15.31	12.11	11.11	12.91
2X10	11.43	15.85	17.85	14.65	13.65	15.45
2X13	15.24	19.66	21.66	18.46	17.46	19.26
2X16	19.05	23.47	25.47	22.27	21.27	23.07
2X20	24.13	28.55	30.55	27.35	26.35	28.15
2X25	30.48	34.90	36.90	33.70	32.70	34.50
2X30	36.83	41.25	43.25	40.05	39.05	40.85
2X34	41.91	46.33	48.33	45.13	44.13	45.93
2X40	49.53	53.95	55.95	52.75	51.75	53.55

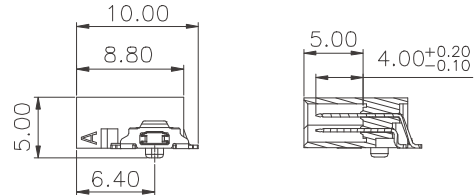
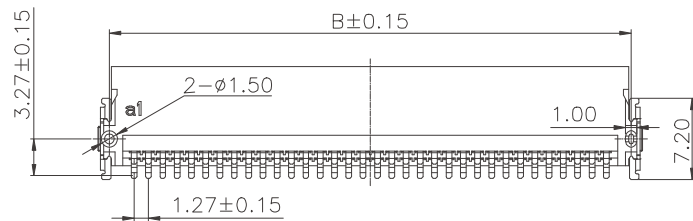

Recommended P.C.Board Layout
(Tolerance:±0.05)

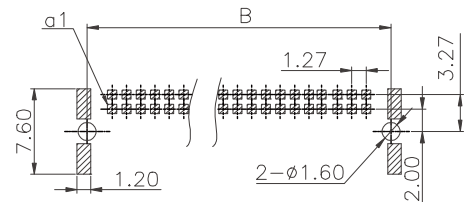

Ordering Information

GBED204 -

No. of Pins per Row

- 05 10 20 30 40
- 06 13 25 34
- 08 16

Standard Plating

05 : 1u" Au / 80~160u" Tin

Selective Plating

- 77 : 15u" Gold / Matte Tin
- 79 : 5u" Au / 80~160u" Matte Tin

B001C

Color

1 : Black

A

Standard Packing

D : Tape&Reel

CBEC223

SERIES

Female

S.M.T.



PRODUCT SPECIFICATIONS

- Current Rating : 1.7 Amp / PIN
- Contact Resistance : 25 mΩ Max.
- Dielectric Withstanding Voltage : 500 VAC
- Insulation Resistance : 10000 MΩ Min.
- Operating Temperature : -55 °C to +125 °C



All materials must meet GREENCONN hazardous substances control standards.

DIMENSIONAL DRAWINGS

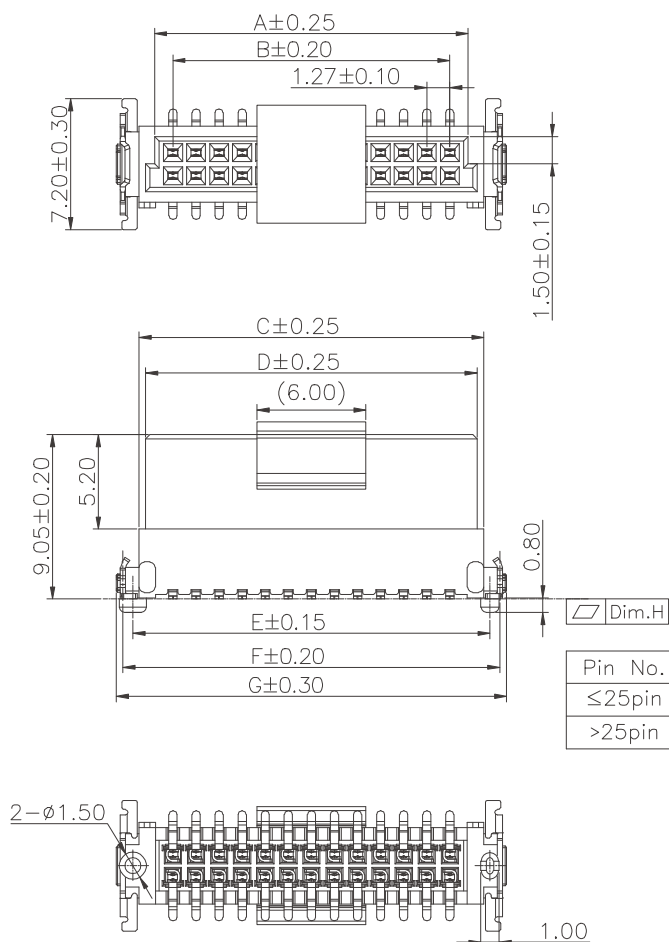

No. of PIN/ROW	Dimension Information						
	A	B	C	D	E	F	G
2x06	8.37	6.35	10.10	9.37	10.77	11.87	12.60
2x08	10.91	8.89	12.64	11.91	13.31	14.41	15.14
2x10	13.45	11.43	15.18	14.45	15.85	16.95	17.68
2x13	17.26	15.24	18.99	18.26	19.66	20.76	21.49
2x16	21.07	19.05	22.80	22.07	23.47	24.57	25.30
2x20	26.15	24.13	27.88	27.15	28.55	29.65	30.38
2x25	32.50	30.48	34.23	33.50	34.90	36.00	36.73
2x34	43.93	41.91	45.66	44.93	46.33	47.43	48.16
2x40	51.55	49.53	53.28	52.55	53.95	55.05	55.78

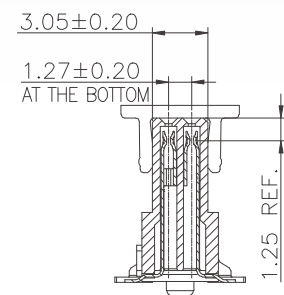

Recommended P.C.Board Layout
(Tolerance:±0.05)

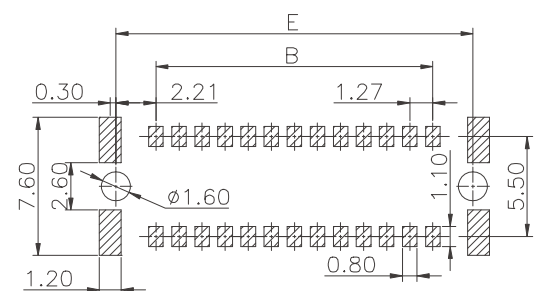

Ordering Information

CBEC223 -

No. of Pins per Row

Standard Plating

: 1u" Au / 80~160u" Tin

Selective Plating

: 5u" Au / 80~160u" Matte Tin

B001C

Color

: Black

A

Standard Packing

: Cap + Tape&Reel

Selective Packing

: Tube

: Cap + Tube

CBEC224

SERIES

Female

S.M.T.

Pitch 1.27 mm

HIGH-SPEED

PRODUCT SPECIFICATIONS

Current Rating : 1.7 Amp / PIN

Contact Resistance : 25 mΩ Max.

Dielectric Withstanding Voltage : 500 VAC

Insulation Resistance : 10000 MΩ Min.

Operating Temperature : -55 °C to +125 °C

All materials must meet GREENCONN hazardous substances control standards.



DIMENSIONAL DRAWINGS

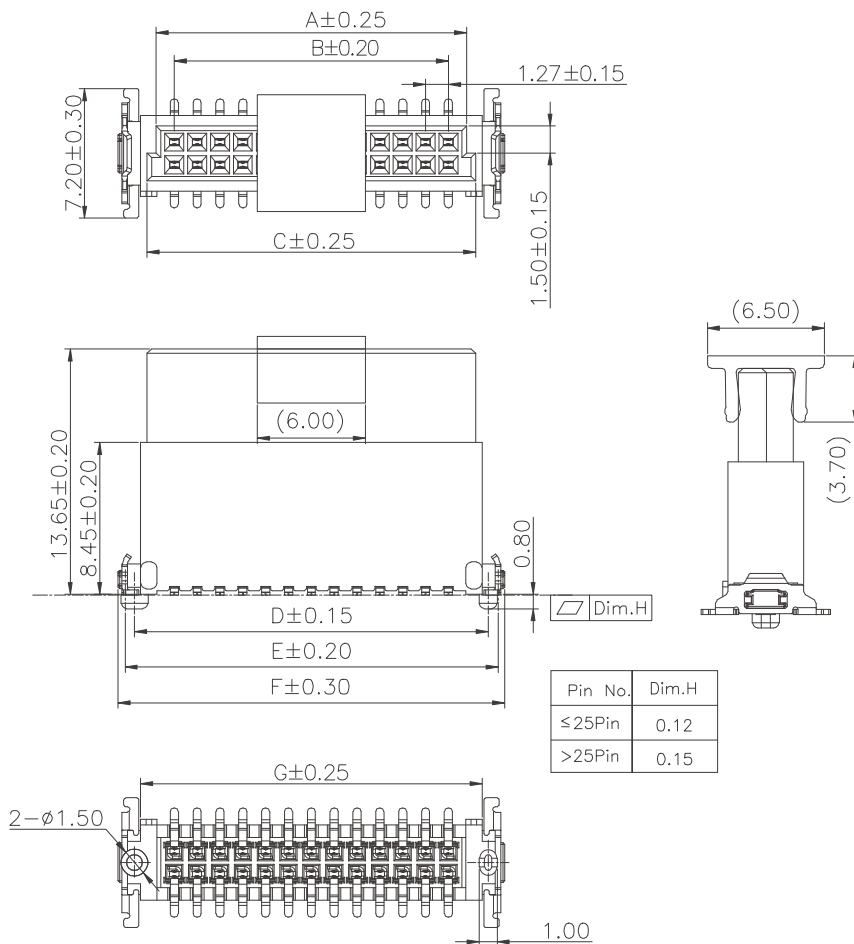

No. of PIN/ROW	Dimension Information						
	A	B	C	D	E	F	G
2x06	8.37	6.35	9.37	10.77	11.87	12.60	10.10
2x08	10.91	8.89	11.91	13.31	14.41	15.14	12.64
2x10	13.45	11.43	14.45	15.85	16.95	17.68	15.18
2x13	17.26	15.24	18.26	19.66	20.76	21.49	18.99
2x16	21.07	19.05	22.07	23.47	24.57	25.30	22.80
2x20	26.15	24.13	27.15	28.55	29.65	30.38	27.88
2x23	29.96	27.94	30.96	32.36	33.46	34.19	31.69
2x25	32.50	30.48	33.50	34.90	36.00	36.73	34.23
2x34	43.93	41.91	44.93	46.33	47.43	48.16	45.66
2x40	51.55	49.53	52.55	53.95	55.05	55.78	53.28

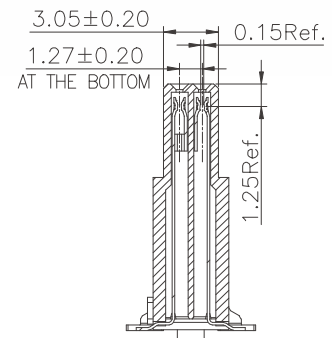

Recommended P.C.Board Layout
(Tolerance: ± 0.05)

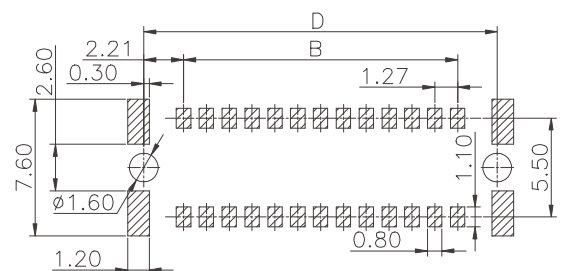

Ordering Information

GBEC224 -

No. of Pins per Row

Standard Plating

: 1u" Au / 80~160u" Tin

Selective Plating

: Gold Flash

: 5u" Au / 80~160u" Matte Tin

B001C

Color

: Black

A

Standard Packing

: Cap + Tape&Reel

Selective Packing

: Tube

: Cap + Tube

CBEC225

SERIES

Female

S.M.T.



PRODUCT SPECIFICATIONS

Current Rating : 1.7 Amp / PIN

Contact Resistance : 25 mΩ Max.

Dielectric Withstanding Voltage : 500 VAC

Insulation Resistance : 10000 MΩ Min.

Operating Temperature : -55 °C to +125 °C

All materials must meet GREENCONN hazardous substances control standards.



DIMENSIONAL DRAWINGS

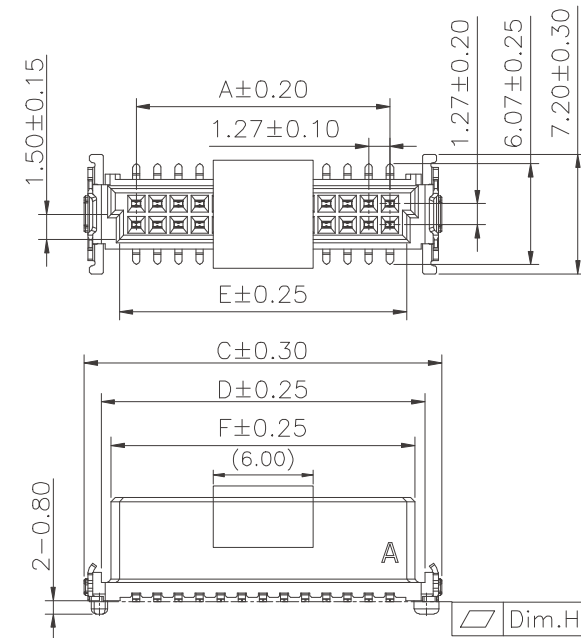

Pin No.	Dim.H
≤ 25 Pin	0.12
> 25 Pin	0.15

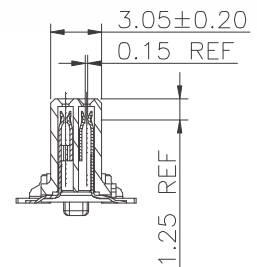
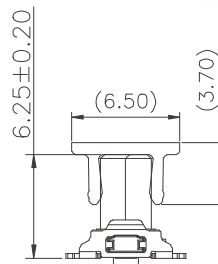
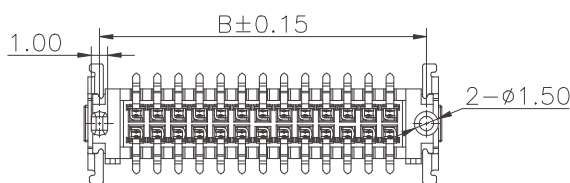

Recommended P.C.Board Layout
(Tolerance: ± 0.05)

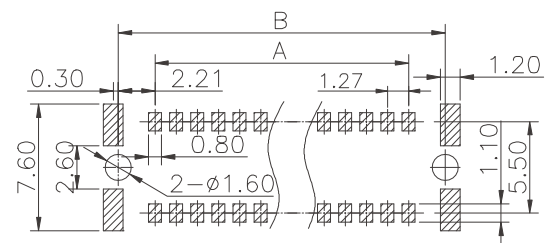

No. of PIN/ROW	Dimension Information					
	A	B	C	D	E	F
2X05	5.08	9.50	11.33	9.30	7.10	8.10
2X06	6.35	10.77	12.60	10.57	8.37	9.37
2X08	8.89	13.31	15.14	13.11	10.91	11.91
2X10	11.43	15.85	17.68	15.65	13.45	14.45
2X13	15.24	19.66	21.49	19.46	17.26	18.26
2X16	19.05	23.47	25.30	23.27	21.07	22.07
2X20	24.13	28.55	30.38	28.35	26.15	27.15
2X25	30.48	34.90	36.73	34.70	32.50	33.50
2X34	41.91	46.33	48.16	46.13	43.93	44.93
2X40	49.53	53.95	55.78	53.75	51.55	52.55

Ordering Information

GBEC225 -

No. of Pins per Row

05 10 20 34 40

06 13 25

08 16

Standard Plating

05 : 1u" Au / 80~160u" Tin

Selective Plating

79 : 5u" Au / 80~160u" Matte Tin

B001C

Color

1 : Black

A

Standard Packing

F : Cap + Tape&Reel

Selective Packing

C : Tube

E : Cap + Tube

CBEC227

SERIES

Female

S.M.T.

Pitch 1.27 mm

HIGH-SPEED
HIGH-SPEED

PRODUCT SPECIFICATIONS

Current Rating : 1.5 Amp / PIN

Contact Resistance : 25 mΩ Max.

Dielectric Withstanding Voltage : 500 VAC

Insulation Resistance : 10000 MΩ Min.

Operating Temperature : -55 °C to +125 °C

All materials must meet GREENCONN hazardous substances control standards.



DIMENSIONAL DRAWINGS

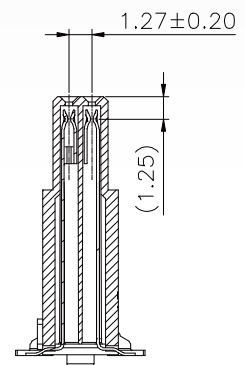
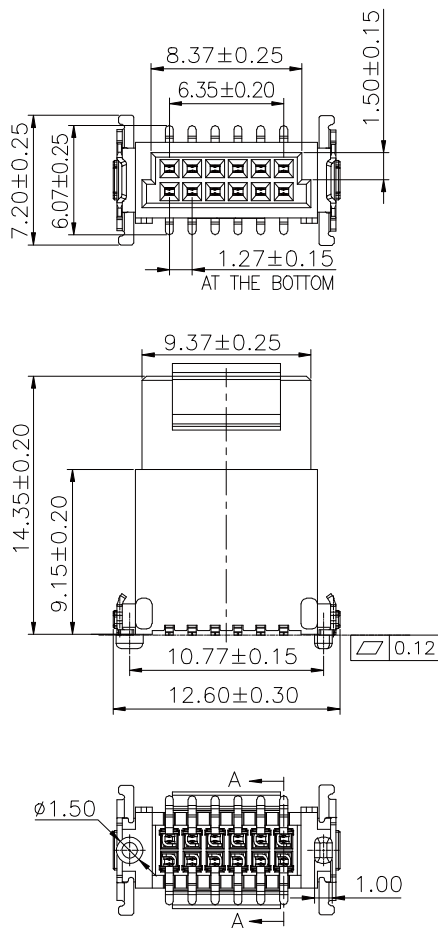

Recommended P.C.Board
Layout
(Tolerance:±0.05)

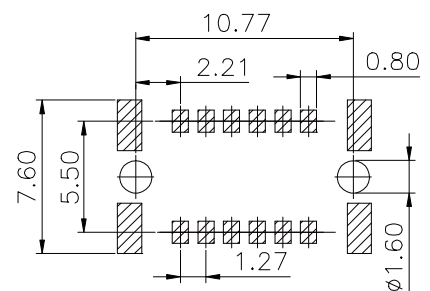

Ordering Information

GBEC227 -

No. of Pins per Row

Standard Plating

: 5u" Au / 80~160u" Matte Tin

B002C

Color

: Black

A

Standard Packing

: Cap + Tape&Reel

CBED202

SERIES

Female

S.M.T. R/A



PRODUCT SPECIFICATIONS

- Current Rating : 1.7 Amp / PIN
- Contact Resistance : 25 mΩ Max.
- Dielectric Withstanding Voltage : 500 VAC
- Insulation Resistance : 10000 MΩ Min.
- Operating Temperature : -55 °C to +125 °C



All materials must meet GREENCONN hazardous substances control standards.

DIMENSIONAL DRAWINGS

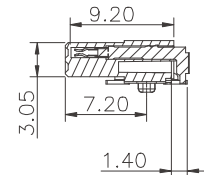
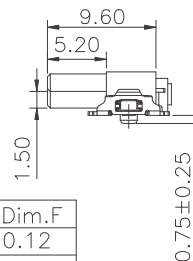
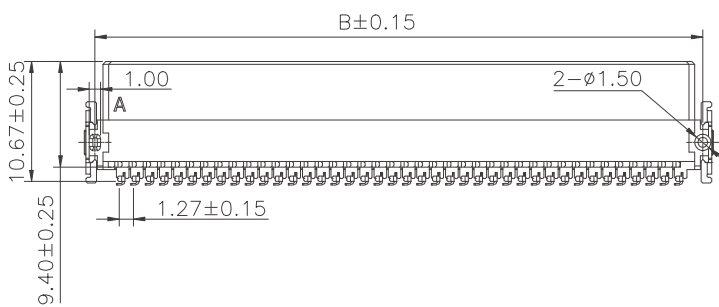
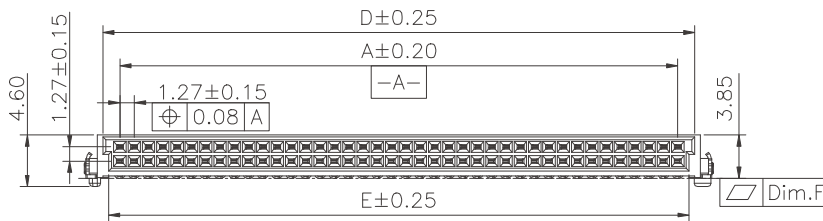
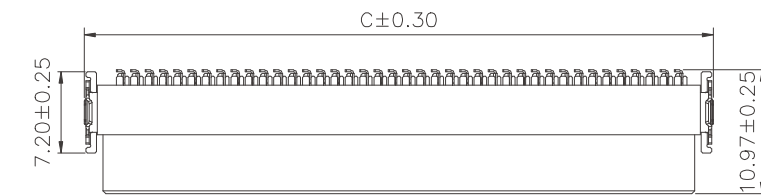

Pin No.	Dim.F
≤25pin	0.12
>25pin	0.15

No. of PIN/ROW	Dimension Information				
	A	B	C	D	E
2X05	5.08	9.50	11.43	8.10	7.10
2X06	6.35	10.77	12.70	9.37	8.37
2X08	8.89	13.31	15.24	11.91	10.91
2X10	11.43	15.85	17.78	14.45	13.45
2X13	15.24	19.66	21.59	18.26	17.26
2X16	19.05	23.47	25.40	22.07	21.07
2X20	24.13	28.56	30.49	27.15	26.15
2X25	30.48	34.90	36.83	33.50	32.50
2X30	36.83	41.25	43.18	39.85	38.85
2X34	41.91	46.33	48.26	44.93	43.93
2X40	49.53	53.95	55.88	52.55	51.55

Recommended P.C.Board Layout
(Tolerance:±0.05)

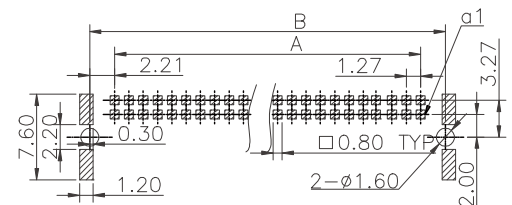

Ordering Information

CBED202 -

No. of Pins per Row

- 05 10 20 30 40
- 06 13 25 34
- 08 16

Standard Plating

05 : 1u" Au / 80~160u" Tin

Selective Plating

- 77 : 15u" Gold / Matte Tin
- 79 : 5u" Au / 80~160u" Matte Tin

B001C

Color

1 : Black

A

Standard Packing

D : Tape&Reel

IDC Socket

17

GQEC201



Cable Assembly

headers

19

CQEA217



cables

20

LQQE2XX



CQEA217

SERIES

IDC Female

Type B



PRODUCT SPECIFICATIONS

Current Rating : 1.1 Amp / PIN

Contact Resistance : 10 mΩ Max.

Dielectric Withstanding Voltage : 500 VAC

Insulation Resistance : 10000 MΩ Min.

Operating Temperature : -55 °C to +125 °C

All materials must meet GREENCONN hazardous substances control standards.



DIMENSIONAL DRAWINGS

No. of PIN/ROW	Dimension Information			
	A	B	C	D
2X06	6.35	8.37	9.37	14.71
2X10	11.43	13.45	14.45	19.79
2X13	15.24	17.26	18.26	23.60
2X16	19.05	21.07	22.07	27.41
2X20	24.13	26.15	27.15	32.49
2X25	30.48	32.50	33.50	38.84
2X34	41.91	43.93	44.93	50.27
2X40	49.53	51.55	52.55	57.89

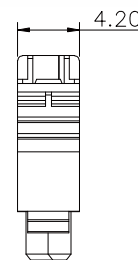
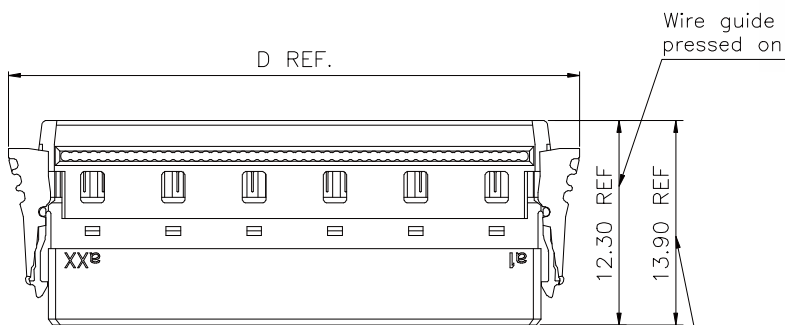
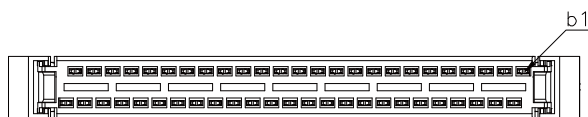

wire guide loose mounted (state at time of supply)

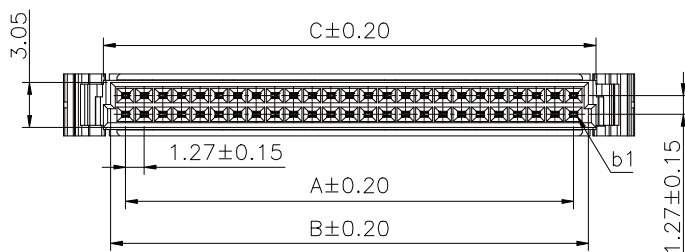

Ordering Information

CQEA217 -

No. of Pins per Row

Standard Plating

: 15u" Gold / Matte Tin

A002C

Color

: Black

A

Standard Packing

: Tray

LQQE2XX

SERIES

IDC Female

Cable

Pitch 1.27 mm

HIGH-SPEED

PRODUCT SPECIFICATIONS

Cable Specification : 30 AWG

Contact Resistance : 50 mΩ Max.

Dielectric Withstanding Voltage : 300 VAC / 0.1s

Insulation Resistance : 1000 MΩ Min.

Operating Temperature : -55 °C to +125 °C

All materials must meet GREENCONN hazardous substances control standards.

DIMENSIONAL DRAWINGS

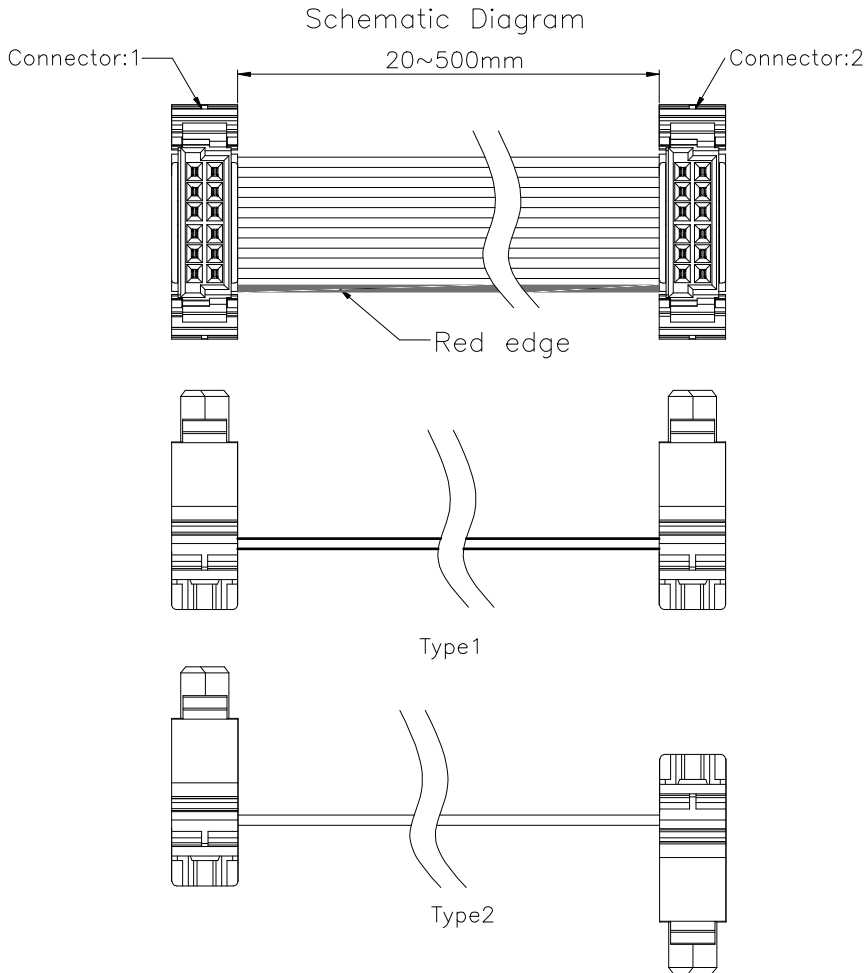

Ordering Information

LQQE2XX -	XX	XX	XXXX	A	30
No. of Pins per Row	Standard Plating	The Length of the Wire	Terminal Shape	Cable Specification	
06 10 20 34 40	77 : 15u" Gold / Matte Tin	20~500 mm	Plastic	AWG	
13 25					
16					

MATING

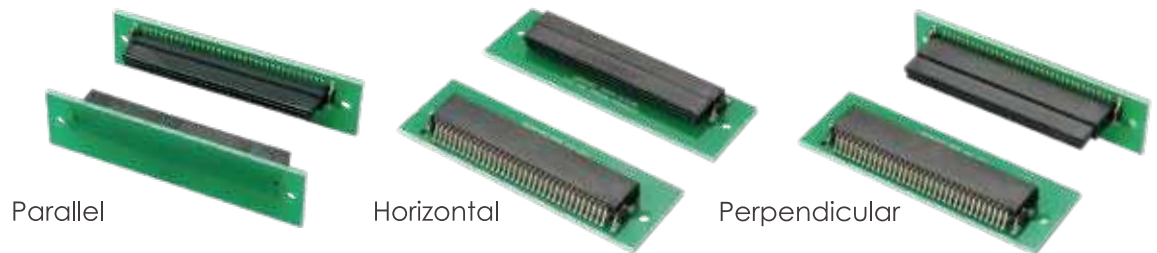

Part No. (male)	Height (mm)	Number of Pins											Part No. of Mating Part (female)	Height (mm)	Mating Height	
		2x5	2x6	2x8	2x10	2x13	2x16	2x20	2x25	2x30	2x34	2x40				
GBEC207	8.25													CBEC223	9.05	12.30 ~ 13.80
														CBEC224	13.70	16.95 ~ 18.45
														CBEC225	6.25	9.50 ~ 11.00
														CBEC227	14.40	17.65 ~ 19.15
														CBED202	10.97	14.25 ~ 15.75
														CQEA217	12.30	15.55
GBEC208	9.85												CBEC223	9.05	13.90 ~ 14.40	
													CBEC224	13.70	18.55 ~ 20.05	
													CBEC225	6.25	11.10 ~ 12.60	
													CBEC227	14.40	19.25 ~ 20.75	
													CBED202	10.97	15.85 ~ 17.35	
													CQEA217	12.30	17.15	
GBEC209	6.75												CBEC223	9.05	10.80 ~ 12.30	
													CBEC224	13.70	15.45 ~ 16.95	
													CBEC225	6.25	8.00 ~ 9.50	
													CBEC227	14.40	16.15 ~ 17.65	
													CBED202	10.97	12.75 ~ 14.25	
													CQEA217	12.30	14.05	
GBED204	10.00												CBEC223	9.05	14.05 ~ 15.55	
													CBEC224	13.70	18.70 ~ 20.20	
													CBEC225	6.25	11.25 ~ 12.75	
													CBEC227	14.40	19.40 ~ 20.90	
													CBED202	10.97	16.00 ~ 17.50	
													CQEA217	12.30	17.30	
GQEC201	5.00											CQEA217	12.30			

PACKAGING

TAPE AND REEL

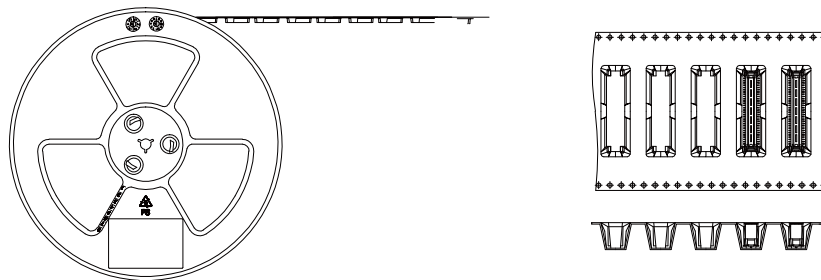

GBEC207	Pcs / Reel	Pcs / Carton	Space (mm)	Reel Width (mm)
- 05XXB001C1AF	350	2800	P=16	W=32
- 06XXB001C1AF		2800		W=32
- 08XXB001C1AF		2800		W=32
- 10XXB001C1AF		2100		W=44
- 13XXB001C1AF		2100		W=44
- 16XXB001C1AF		2100		W=44
- 20XXB001C1AF		1750		W=56
- 23XXB001C1AF		1750		W=56
- 25XXB001C1AF		1750		W=56
- 34XXB001C1AF		1400		W=72
- 40XXB001C1AF		1050		W=88

GBEC209	Pcs / Reel	Pcs / Carton	Space (mm)	Reel Width (mm)
- 05XXB001C1AF	450	3600	P=16	W=32
- 06XXB001C1AF		3600		W=32
- 08XXB001C1AF		3600		W=32
- 10XXB001C1AF		2700		W=44
- 13XXB001C1AF		2700		W=44
- 16XXB001C1AF		2700		W=44
- 20XXB001C1AF		2250		W=56
- 23XXB001C1AF		2250		W=56
- 25XXB001C1AF		2250		W=56
- 34XXB001C1AF		1800		W=72
- 40XXB001C1AF		1350		W=88

GBEC208	Pcs / Reel	Pcs / Carton	Space (mm)	Reel Width (mm)
- 05XXB001C1AF	300	2400	P=16	W=32
- 06XXB001C1AF		2400		W=32
- 08XXB001C1AF		2400		W=32
- 10XXB001C1AF		1800		W=44
- 13XXB001C1AF		1800		W=44
- 16XXB001C1AF		1800		W=44
- 20XXB001C1AF		1500		W=56
- 25XXB001C1AF		1500		W=56
- 34XXB001C1AF		1200		W=72
- 40XXB001C1AF		900		W=88

GBED204	Pcs / Reel	Pcs / Carton	Space (mm)	Reel Width (mm)
- 05XXB001C1AF	700	5600	P=16	W=32
- 06XXB001C1AF		5600		W=32
- 08XXB001C1AF		5600		W=32
- 10XXB001C1AF		4200		W=44
- 13XXB001C1AF		4200		W=44
- 16XXB001C1AF		4200		W=44
- 20XXB001C1AF		3500		W=56
- 25XXB001C1AF		3500		W=56
- 34XXB001C1AF		2800		W=72
- 40XXB001C1AF		2800		W=72

GQEC201	Pcs / Reel	Pcs / Carton	Space (mm)	Reel Width (mm)
- 25XXB001C1AF	560	2800	P=16	W=56

PACKAGING

■ TAPE AND REEL

CBEC223	Pcs / Reel	Pcs / Carton	Space (mm)	Reel Width (mm)
- 06XXB001C1AF	350	2800	P=16	W=32
- 08XXB001C1AF		2800		W=32
- 10XXB001C1AF		2100		W=44
- 13XXB001C1AF		2100		W=44
- 16XXB001C1AF		2100		W=44
- 20XXB001C1AF		1750		W=56
- 25XXB001C1AF		1750		W=56
- 30XXB001C1AF		1750		W=56
- 34XXB001C1AF		1400		W=72
- 40XXB001C1AF		1050		W=88

CBEC225	Pcs / Reel	Pcs / Carton	Space (mm)	Reel Width (mm)
- 05XXB001C1AF	450	3600	P=16	W=32
- 06XXB001C1AF		3600		W=32
- 08XXB001C1AF		3600		W=32
- 10XXB001C1AF		2700		W=44
- 13XXB001C1AF		2700		W=44
- 16XXB001C1AF		2700		W=44
- 20XXB001C1AF		2250		W=56
- 25XXB001C1AF		2250		W=56
- 34XXB001C1AF		1800		W=72
- 40XXB001C1AF		1350		W=88

CBEC224	Pcs / Reel	Pcs / Carton	Space (mm)	Reel Width (mm)
- 06XXB001C1AF	200	1600	P=16	W=32
- 08XXB001C1AF		1600		W=32
- 10XXB001C1AF		1200		W=44
- 13XXB001C1AF		1200		W=44
- 16XXB001C1AF		1200		W=44
- 20XXB001C1AF		1000		W=56
- 23XXB001C1AF		1000		W=56
- 25XXB001C1AF		1000		W=56
- 30XXB001C1AF		800		W=72
- 34XXB001C1AF		800		W=72
- 40XXB001C1AF	600	W=88		

CBEC227	Pcs / Reel	Pcs / Carton	Space (mm)	Reel Width (mm)
- 06XXB002C1AF	150	1200	P=20	W=32

CBED202	Pcs / Reel	Pcs / Carton	Space (mm)	Reel Width (mm)
- 05XXB001C1AF	700	7000	P=16	W=24
- 06XXB001C1AF		7000		W=24
- 08XXB001C1AF		5600		W=32
- 10XXB001C1AF		5600		W=32
- 13XXB001C1AF		4200		W=44
- 16XXB001C1AF		4200		W=44
- 20XXB001C1AF		3500		W=56
- 25XXB001C1AF		3500		W=56
- 30XXB001C1AF		3500		W=56
- 34XXB001C1AF		2800		W=72
- 40XXB001C1AF	2800	W=72		

■ TRAY

CQEA217	Pcs / Tray	Pcs / Carton
- 06XXA002C1SB	144	2160
- 10XXA002C1SB	104	1560
- 13XXA002C1SB	88	1320
- 16XXA002C1SB	80	1200
- 20XXA002C1SB	64	960
- 25XXA002C1SB	56	840
- 34XXA002C1SB	40	600
- 40XXA002C1SB	32	480



Greenconn
格 棱 格 棱 格 康

HIGH-SPEED CONNECTORS

Asia

Ganzhou/China
GREENCONN TECHNOLOGY (Ganzhou) LTD.
☎ +86 - 797 6635 510
☎ +86 - 797 6635 653

Kunshan/China
Kunshan Greenconn Technology Co., Ltd.
☎ +86 - 512 5782 5636
☎ +86 - 512 5031 6595

Shenzhen/China
Greenconn Technology (shenzhen) Co., Ltd.
☎ +86 - 755 2707 0050 / 1
☎ +86 - 755 2707 0056

New Taipei/Taiwan
Greenconn Corporation
☎ +886 - 2 2209 1343
☎ +886 - 2 2903 0754

Osaka/Japan
Greenconn Japan Co., Ltd.
☎ +81 - 6 6614 9711

America

Toronto/Canada
GREENCONN TECHNOLOGY Ltd.
☎ +1 - 704 493 1478

ver. 202308



www.greenconn.com
sales@greenconn.com

